

V O L V O



V O L V O

DIPLOMATIC
SALES

VOLVO XC40
RECHARGE PURE ELECTRIC

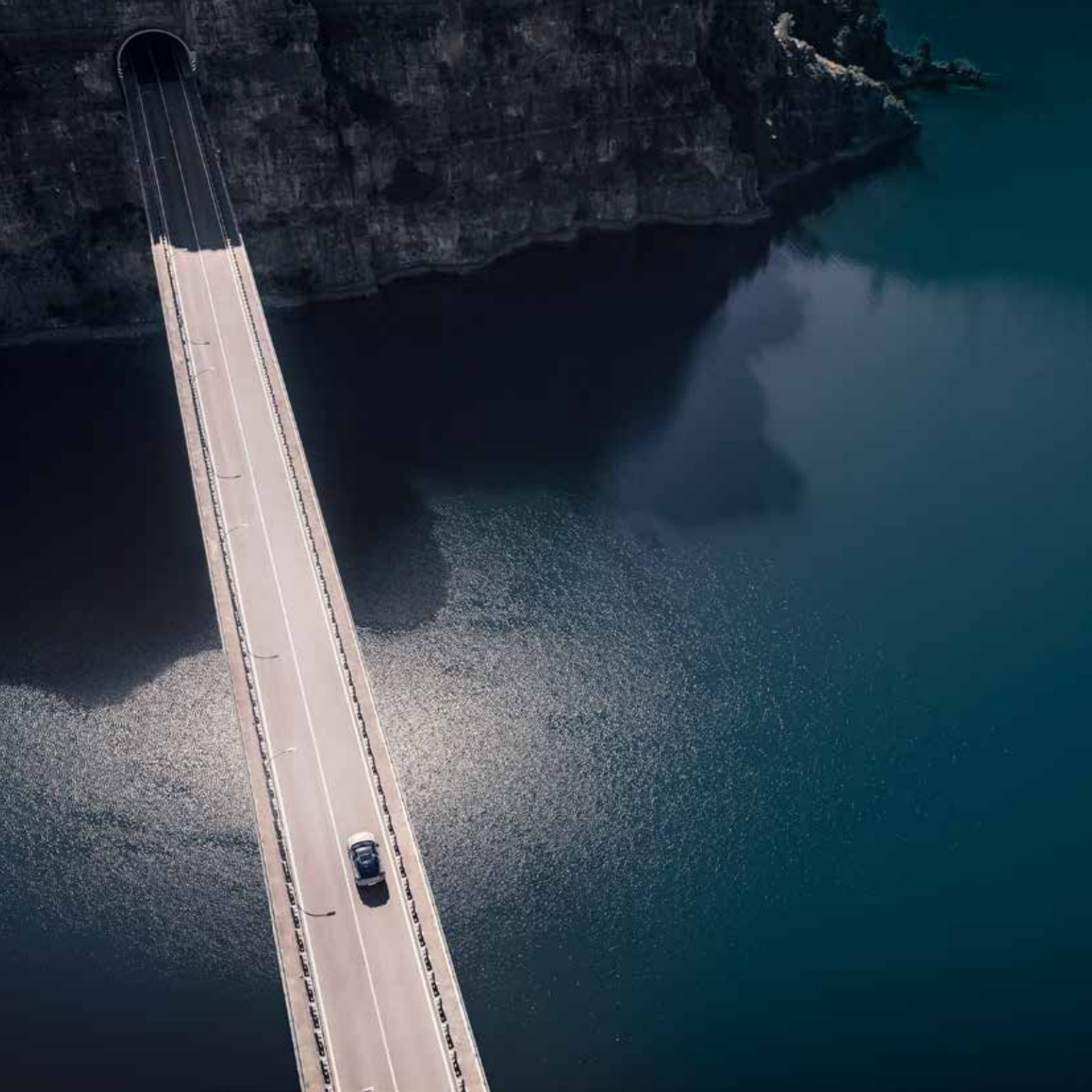

p 3 Volvo XC40 Recharge pure electric offer

p 4-5 Standard equipment Core

p 6 Trim levels

p 7 Exterior

p 8 Wheels

p 8-9 Interior

p 10 Options

p 10 Accessory packs

p 12-13 Accessories

p 14 Technical specifications

p 15 Volvo Care Offer

MADE BY
SWEDEN | BUILT IN
BELGIUM

VOLVO XC40 RECHARGE PURE ELECTRIC OFFER

Engine(s)	Transmission	Power output hp/kW	Battery capacity kWh nominal/usable	CO ₂ emissions WLTP	CO ₂ emissions NEDC 2.0	List price € excl. VAT	List price € incl. VAT BE	List price € incl. VAT LU ⁽¹⁾
XC40 RECHARGE CORE								
One engine (FWD)	Single-speed	231/170	69/67	0	0	39.710,74	48.050	46.462
XC40 RECHARGE PLUS								
One engine (FWD)	Single-speed	231/170	69/67	0	0	41.487,60	50.200	48.540
XC40 RECHARGE PRO								
One engine (FWD)	Single-speed	231/170	69/67	0	0	45.000,00	54.450	52.650
XC40 RECHARGE TWIN PLUS								
Two engines (AWD)	Single-speed	408/300	78/75	0	0	50.413,22	61.000	58.983
XC40 RECHARGE TWIN PRO								
Two engines (AWD)	Single-speed	408/300	78/75	0	0	53.719,01	65.000	62.851

Vehicles destined for EEA. The models listed above are destined for the European Economic Area ('EEA') market. Volvo Cars does not guarantee the compatibility of these models with any rules or regulations applicable outside the EEA. If you export these models outside of the EEA or if you request us to do so for you, such export will take place at your own risk.

Export of vehicles. Export outside of the country of purchase in any event occurs at your risk and cost. The prices listed above are exclusive of freight charges, taxes, licenses and any other documentation related to the export of your vehicle outside of the country of purchase. In case of export, the dealer will request you to deposit the amount of VAT applicable in the country of purchase as a guarantee. The dealer will reimburse the relevant amount to you upon receipt of (i) proof that you are exempted from VAT in the country where the vehicle is registered, or (ii) proof that VAT has been paid in the country where the vehicle is registered.

(1) Prices. A delivery fee of € 250 (excl. VAT) will be added to the prices listed above for vehicles supplied in the Grand Duchy of Luxembourg. The above-listed prices are furthermore exclusive of dealer preparation fees. Therefore, additional charges may be applied at your delivery point. Finally, you will be responsible for the payment of VAT (as applicable in the country of first registration of your vehicle) and any other taxes, as well as any registration and similar fees, all to the extent applicable. For ease of reference, VAT as currently applicable in Belgium and the Grand Duchy of Luxembourg are listed above.

3 YEARS OF MAINTENANCE AND REPLACEMENT OF WEAR & TEAR PARTS INCLUDED*
(limited to 100.000 km)

3 YEARS OR 100.000 KM FACTORY WARRANTY INCLUDED
(whichever comes first)

* The Volvo Care Offer 'Service & Maintenance for Volvo Recharge Pure Electric' applies to the vehicle specified above, and for a period of **3 years from the date of delivery or 100.000 km** (whichever comes first). The Volvo Care Offer 'Service & Maintenance for Volvo Recharge Pure Electric' covers periodic maintenance services, every **24 months or every 30.000 km** (whichever comes first), and includes replacement of the wear and tear parts listed below.

- Volvo Car Genuine Service at scheduled service intervals
- health check
- air filter replacement
- tyre sealant replacement in accordance with the prescribed interval
- cleaning of the sensors and cameras for the safety systems under the windscreen
- software updates

- **Includes** replacement of the following wear and tear parts: brake pads and discs (when required) and windscreen wiper blades (1x per year).
- **Excludes** replacement of wear and tear parts not explicitly mentioned above.

For more information about the Volvo Care Offer 'Service & Maintenance for Volvo Recharge Pure Electric', see page 15 of this price list.

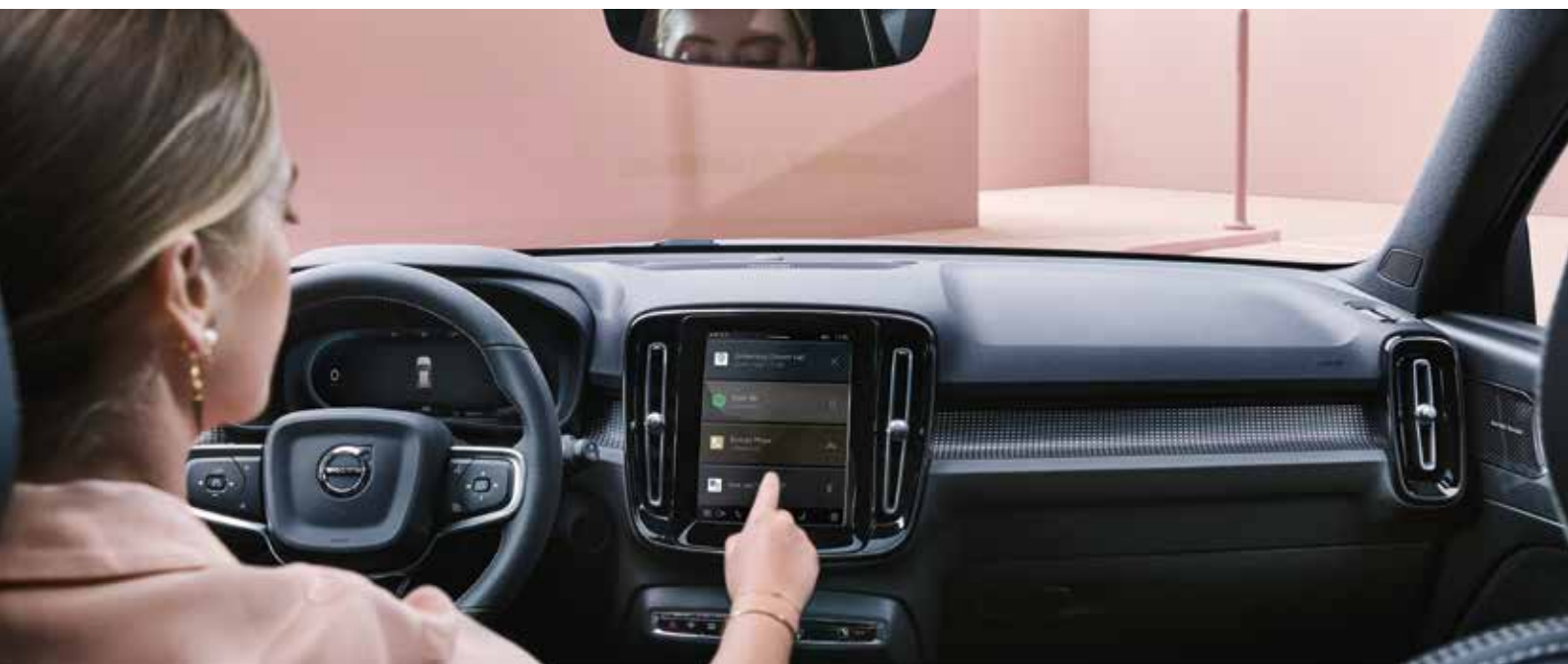

STANDARD EQUIPMENT CORE

SAFETY

Stability and traction control: Electronic Stability Control (ESC) including Active Yaw Control, Understeer Control Logic, Advanced Stability Control, Roll Stability Control, Driver Steering Recommendation, Dynamic Torque Vectoring, Trailer Stability Assist (only with the tow bar) and Hill Descent Control | Traction Control (TC) including Corner Traction Control with Torque Vectoring | Spin Control including Engine Drag Control

Advanced Driver Assist System (ADAS) sensor platform

City Safety system: helps the driver to avoid or attenuate collisions with other vehicles (including those coming in the opposite direction at crossroads), cyclists, pedestrians (active up to a speed difference of 50 km/h, day and night), including active braking assistance

Cruise control with speed limiter

Lane Keeping Aid: helps the driver to stay in lane (active from 65 km/h), including Run-off Road Mitigation: helps prevent the vehicle from running off the road, with steering aid and braking intervention (active between 65 and 140 km/h)

Oncoming Lane Mitigation: helps the driver to avoid collisions with vehicles coming in the opposite direction by automatically adjusting the steering

Driver Alert Control (DAC): system that detects and warns of tiredness

Connected Safety technology including Slippery Road Alert and Hazard Light Alert

Automatic braking after a collision

Indirect Tyre Pressure Monitoring System (iTTPMS)

Ultra-resistant structure of vehicle interior and roof in boron steel

Collapsible steering column

Automatic unlocking after a collision

Height-adjustable seat belts in front and with pre-tensioners and load limiters front and rear

Front airbags including driver's knee airbag, SIPS® side airbags and inflatable curtains

WHIPS® (Whiplash Injury Protection System): provides protection against injuries due to whiplash thanks to specific energy-absorbing backrests and seats and head restraints integrated into the front seats

Brake Pedal Release: automatic release of brake pedal, by means of a pyrotechnic device, in the event of an accident to attenuate injuries to feet, legs and back

Emergency brake lights

Power-operated child safety lock on rear doors

Isofix anchorages for the outer positions of the rear seat

Front passenger airbag cut-off switch

Acoustic Vehicle Alerting System (AVAS) at slow speed

DRIVER ASSISTANCE

Road Sign Information (RSI) with Speed Limiter: display of road sign information with excess speed warning and automatic speed limiter

Ready to Drive notification: function that informs the driver via a sound and a visual notification if the vehicle is still standing still even though the vehicle in front has moved a certain distance or exceeded a certain speed.

PERSONAL SAFETY AND CONVENIENCE

Keyless Entry: passive (un)locking, hands-free tailgate opening/closing (foot movement under the rear bumper), LED entry light and lighting in the door handles

Power-operated tailgate

Convenient Entry and Start that among other things eliminates the need of a start button. When the driver is seated, the car starts as he/she presses the brake pedal and engages Drive or Reverse

Welcome lighting when the driver is approaching the car

One Pedal Drive: possibility to use only one pedal to accelerate or brake. Just by lifting the pedal the driver can, on a short distance, slow the car all the way to standstill not having to use the brake pedal

Electric parking brake with Auto Hold (automatic brake at a standstill) and Hill Start Assist (assistance to start on a hill or slope) functions

Immobiliser

One remote control and one "Care Key" which allows you to set a lower maximal speed (<180 km/h)

Tyre repair kit in the Frunk

CLIMATE CONTROL

Two-zone electronic automatic climate control system with air vents at the rear, humidity sensor, air recirculation function and pollen filter

Clean Zone: IAQS (Interior Air Quality System) to improve air quality inside the vehicle, with active filter

Interior climate preconditioning (cabin cooling or heating, including heating of the front seats and steering wheel)

Front wipers blades with integrated washers ("Aquablades")

Rain sensor with adjustable sensitivity level

INTERIOR

Textile City Canvas upholstery

Comfort front seats with manual adjustable height and length and manual seat cushion extension

Adjustable driver seat cushion incline

Power-operated four-way lumbar support

Heated front seats

Rear seats with central armrest with cup holder, load hatch and folding back in two parts (60/40)

Charcoal central console at front with armrest and large storage compartment, two cup holders and two open storage compartments

High Gloss Black finish on the central console and centre display trim and the front air vents

Cutting Edge aluminium inlay in dashboard and doors, including dimmed lighting in dashboard

Interior lighting Pro (very generous amount of interior lighting including vanity mirrors with light, front and rear reading lights, load compartment lighting and dimmed lighting at front and rear)

Black headlining

Inner rear-view mirror with automatic dimming

Heated black leather-free sport steering wheel with Silk Metal Inlay

Black sport simili-leather gear lever knob

Recharge aluminium door sills at front

Textile floor mats at front and rear in Charcoal Melange

Aluminium sport pedals

STANDARD EQUIPMENT CORE

VERSATILITY

Frunk: 31 liter front load compartment
Very spacious storage bins in front doors
2 USB-C connections at the front of the central console and two at the back
Removable litter bin with lid in the central console
Ticket holder on driver's side of the windscreen
Folding hook in the glove compartment lid to hang small bags
Storage pockets in backrest of front seats
Nylon safety net between the rear seats and the luggage compartment
Flat load floor with bench seat back folded down
Rigid, detachable luggage cover, that can be stored beneath the luggage compartment floor
Storage space beneath luggage compartment floor
Multifunction folding load floor with shopping bag hook
Four shopping bag hooks and four folding load retainer eyelets in luggage compartment

MULTIMEDIA & CONNECTIVITY

New generation 12,3" driver information display with two new display modes : Calm and Navi
New generation infotainment system with Google Services: 4 year subscription included to enjoy the different Services
Navigation via Google Maps
Speech and planning of route with Google Assistant "Hey, Google"
9" central touchscreen to control most of the functions
High Performance audio system with 8 speakers (1 full-range and 1 air woofer beneath the windscreen, 2 tweeters in front and 4 mid-range front and rear) and High Performance 250 W amplifier
Wireless charging for smartphone in the front storage compartment (electromagnetic induction technology)
Volvo Cars: integrated assistance service with E-Call function and SOS assistance service for emergencies | Volvo Cars services for roadside assistance via Volvo Assistance | Four-year subscription included
Finding Charging via the centre display – find public charging stations directly from the car
Entertainment with access to a wide range of existing and coming in-car apps
Controls integrated into steering wheel for driver display, cruise control, audio, phone, navigation system and voice commands
DAB+ (Digital Audio Broadcasting)

EXTERIOR

10A charging cable with Schuko socket (for domestic use), length 7 m
16A 3-phase charging cable, Mode 3, with Mennekes socket (for charging point), length 4,5 m
Charging port located in the left rear wing
11 kW onboard charger (AC-DC converter)
Covered grille with body coloured grille frame
Specific rear bumper with no tailpipe
LED headlights with integrated T-shaped daytime running lights, automatic level adjustment, Active High Beam and Volvo Safety Lights
19" 5-spoke Black Diamond Cut alloy wheels
235/50 R19 front Recharge™ (all season) tyres, 255/45 R19 rear Recharge™ (all season) tyres
Dynamic chassis
Wheel arches and lower bodywork parts in Matt Black plastic
Power retractable heated outer rear-view mirrors with integrated LED indicator. With automatic dimming
Roof and rear-view mirror caps in contrasting Solid Black
High Gloss Black trim on lower part of side windows
Glossy Black skidplates front and rear
Integrated Glossy Black roof rails
Recharge emblem in relief on the rear roof pillar and Recharge or Recharge Twin emblem on tailgate
Rear Park Assist Camera (on Pro, replaced by 360° Park Assist Camera)
Rear and Front Park Assist



TRIM LEVELS

PLUS

Includes the XC40 Core equipment supplemented by the specific Plus equipment

INTERIOR

Volvo Guard alarm with movement and inclination sensor and Private Locking for tailgate

Heat pump

EXTERIOR

Adaptive Cruise Control that can support you to keep a set distance to the car in front at all speeds

Pilot Assist that together with Adaptive Cruise Control enables empowered driving on motorways and roads with side ground marking up to a speed of 130 km/h. Also includes Emergency Stop Assist function that can bring the vehicle to a complete stop in lane in situations where the driver is not responding to hands-off warnings

Advanced safety alert and intervention system, including BLIS (Blind Spot Information System with steering assistance), Rear Collision Warning with automatic emergency braking, Prepared Front Safety Belts and Cross Traffic Alert (detection of vehicles coming from the side when reversing)

PRO

Includes the Plus equipment supplemented by the specific Pro equipment

INTERIOR

Power-operated driver seat with memory function for seat position and external rear-view mirrors

Power-operated front passenger seat

Power folding of the rear headrests

Harman Kardon audio system with 13 loud speakers (1 full-range and 1 air woofer beneath the windscreen, 2 tweeters, 4 mid-range, 2 woofers, 2 full-range surround and 1 ventilated subwoofer) and 660 W amplifier

EXTERIOR

360° Park Assist Camera with bird's-eye view (replaces the Rear Park Assist Camera)

Rear, Front and Side Park Assist

Tilt and slide panoramic sunroof with integrated power-operated sun curtain









Full LED directional headlights with Active High Beam

LED front fog lights



High-pressure headlight washers



EXTERIOR

			List price € excl. VAT	List price € incl. VAT BE	List price € incl. VAT LU	CORE	PLUS	PRO
SOLID PAINT								
	019	Solid Black	0,00	0	0	●	●	●
METALLIC PAINT								
	717	Onyx Black Metallic	739,67	895	865	○	○	○
	723	Denim Blue Metallic	739,67	895	865	○	○	○
	725	Fusion Red Metallic	739,67	895	865	○	○	○
	728	Thunder Grey Metallic	739,67	895	865	○	○	○
	729	Glacier Silver Metallic	739,67	895	865	○	○	○
EXCLUSIVE METALLIC PAINT								
	707	Crystal White Pearl	1.012,40	1.225	1.185	○	○	○
	733	Sage Green Metallic	1.012,40	1.225	1.185	○	○	○

WHEELS

		List price € excl. VAT	List price € incl. VAT BE	List price € incl. VAT LU	CORE	PLUS	PRO
19" ALLOY WHEELS							
	- 19" 5-spoke Black Diamond Cut 235/50 R19 Front Recharge™ all seasons tyres 255/45 R19 Rear Recharge™ all season tyres Tyre class A	0,00	0	0	●	●	●
20" ALLOY WHEELS							
	1133 20" 5-double spoke Black Diamond Cut 235/45 R20 Front Recharge™ all seasons tyres 255/40 R20 Rear Recharge™ all season tyres Tyre class A	553,72	670	648	O	O	O

O = Option | ● = Included in trim level



INTERIOR

		List price € excl. VAT	List price € incl. VAT BE	List price € incl. VAT LU	CORE	PLUS	PRO
COMFORT SEATS, TEXTILE CITY CANVAS							
R780	Interior base colour: Charcoal	0,00	0	0	●	●	●
	Colour seats: Charcoal						
	Colour headlining: Charcoal						
	Colour dashboard and front door inlays: Cutting Edge aluminium						



COMFORT SEATS, CONNECT NUBUCK TEXTILE/MICROTECH							
R980	Interior base colour: Charcoal	1.322,31	1.600	1.547	O	O	O
	Colour seats: Charcoal						
	Colour headlining: Charcoal						
	Colour dashboard and front door inlays: Cutting Edge aluminium						



OPTIONS

		List price € excl. VAT	List price € incl. VAT BE	List price € incl. VAT LU	CORE	PLUS	PRO
RECHARGE							
1178	16A 3-phase charging cable with CEE socket (for 5-pin red industrial socket), length 4,5 m (replaces standard 16A 3-phase charging cable, Mode 3, with Mennekes socket)	0,00	0	0	0	0	0
EXTERIOR & LIGHTING							
179	Privacy glass for rear windows	330,58	400	387	0	0	0
VERSATILITY							
1028	Semi-automatic retractable tow bar with 13-pin outlet (Trailer Stability Assist system included)	950,41	1.150	1.112	0	0	0

O = Option

ACCESSORY PACKS

		List price € excl. VAT	List price € incl. VAT BE	List price € incl. VAT LU	CORE	PLUS	PRO
PROTECTION PACK							
A00112 Moulded plastic load compartment protection							
A00492 Rubber floor mat front and rear, including tunnel mat							
PA001		161,16	195	189	0	0	0

TRAVEL PACK							
A00104 Aluminium transversal roof bars							
A00111 Lock kit - one key system							
A00620 "Designed by Volvo" roof box, glossy black (350 L, 223x94x30 cm), with LED interior light							
PA002		991,74	1.200	1.160	0	0	0

SAFETY PACK							
A00106 Luggage net to be attached to load securing eyelets							
A00189 Steel protective grille between the load compartment and the rear seat							
A00217 Anti-theft wheel locks							
PA003		227,27	275	266	0	0	0

O = Option



ACCESSORIES

	List price € excl. VAT	List price € incl. VAT BE	List price € incl. VAT LU	CORE	PLUS	PRO
MULTIMEDIA & CONNECTIVITY						
- One-year extension of the Volvo Cars subscription	32,23	39	38	0	0	0
- Two-year extension of the Volvo Cars subscription	55,37	67	65	0	0	0
RECHARGE						
A01230 Wallbox (until 22 kW) standard installation included*	1,723,14	2.085	2.016	0	0	0
A01150 Charging cord 1P 10A with Schuko socket (for domestic use), length 7 metres	326,45	395	382	0	0	0
A01151 Charging cord 3P 16A with CEE socket (for red industrial socket, 5 pins), length 4,5 metres	409,09	495	479	0	0	0
A01152 Charging cord 1P 16A with CEE socket (for blue industrial socket, 3 pins), length 7 metres	326,45	395	382	0	0	0
A01153 Charging cord 3P 16A mode 3 (type 2) with Mennekes socket (for charging point), length 4,5 metres	326,45	395	382	0	0	0
A01154 Charging cord 1P 16A mode 3 (type 2) with Mennekes socket (for charging point), length 7 metres	326,45	395	382	0	0	0
A01247 Charging cable storage bag	45,45	55	53	0	0	0
LUGGAGE COMPARTMENT						
A00112 Moulded plastic load compartment protection	103,31	125	121	0	0	0
A00382 Textile/plastic reversible load compartment floor mat	144,63	175	169	0	0	0
A00106 Luggage net to be attached to load securing eyelets	41,32	50	48	0	0	0
A00189 Steel protective grille between the load compartment and the rear seat	206,61	250	242	0	0	0
- Nylon safety net between the luggage compartment and the rear seat	103,31	125	121	0	0	0
COMFORT						
A00492 Rubber floor mat front and rear, including tunnel mat	82,64	100	97	0	0	0
A00744 Windscreen sunshade	82,64	100	97	0	0	0
A00264 Glasses holder	33,06	40	39	0	0	0
A00530 Ashtray	20,66	25	24	0	0	0
- Front seat cover	95,04	115	111	0	0	0
A00761 Wool neck cushion (Charcoal or Blond)	41,32	50	48	0	0	0
A00763 Nubuck neck cushion (Blond)	41,32	50	48	0	0	0
A00769 Wool cushion (Charcoal)	41,32	50	48	0	0	0
DESIGN						
A00853 Roof spoiler	330,58	400	387	0	0	0
A01131 Exterior Styling Kit: consists of a brushed stainless steel protective plate front, rear and on the sides	1.652,89	2.000	1.934	0	0	0
A01144 Skidplate Kit: consists of a front and rear brushed stainless steel protective plate	1.239,67	1.500	1.450	0	0	0
INTERIOR STYLING						
A00490 Key fob shell, Linear wood	123,97	150	145	0	0	0
A00491 Key fob shell, Flame Birch wood	123,97	150	145	0	0	0
A00594 Illuminated tailgate scuff plate, Charcoal	330,58	400	387	0	0	0
VERSATILITY						
A00463 Preparation for mounting tow bar as accessory	0,00	0	0	0	0	0
Semi-automatic retractable tow bar with 13-pin outlet (Trailer Stability Assist system included)	950,41	1.150	1.112	0	0	0
A00380 Bicycle holder on tow bar for two bicycles	392,56	475	459	0	0	0
A00425 Folding bicycle holder on tow bar for two bicycles	454,55	550	532	0	0	0
A01238 Folding bicycle holder on tow bar for two bicycles (Fix4Bike)	578,51	700	677	0	0	0
A00042 Bicycle holder on tow bar for three bicycles	475,21	575	556	0	0	0
A00017 Adapter for extra bike (only with A00042 and A01239)	103,31	125	121	0	0	0
A01239 Bicycle holder on tow bar for three bicycles (Fix4Bike)	599,17	725	701	0	0	0
A00104 Aluminium transversal roof bars	206,61	250	242	0	0	0
A00474 Sport Time 2003 roof box, glossy black (400L, 175x82x45 cm)	330,58	400	387	0	0	0
A00234 Space Design 420 roof box, glossy black (320L, 206x84x34 cm)	537,19	650	629	0	0	0
A00238 Space Design 520 roof box, glossy black (430L, 235x94x35 cm)	619,83	750	725	0	0	0
A00620 "Designed by Volvo" roof box, glossy black (350L, 223x94x30 cm), with LED interior light	867,77	1.050	1.015	0	0	0
A00221 Ski holder, (4 pairs of skis) to mount on roof bars	123,97	150	145	0	0	0
A00219 Ski holder, (6 pairs of skis) to mount on roof bars	165,29	200	193	0	0	0
A01143 Ski holder, sliding, to be fitted on load carrier	144,63	175	169	0	0	0
A00111 Lock kit - one key system	41,32	50	48	0	0	0
A00025 Bicycle holder with frame bracket (aluminium), to be fitted on load carrier (1 bicycle)	103,31	125	121	0	0	0

O = Option

ACCESSORIES

		List price € excl. VAT	List price € incl. VAT BE	List price € incl. VAT LU	CORE	PLUS	PRO
CHILD SAFETY							
A00096	Kick guard with storage pockets	41,32	50	48	0	0	0
A00379	Booster seat with detachable backrest in wool (15-36 kg)	181,82	220	213	0	0	0
A00329	Child seat group 2/3 (15-36 kg) with Isofix anchorage	243,80	295	285	0	0	0
A00328	Child seat group 1/2 (9-25 kg), rearward facing	309,92	375	363	0	0	0
A01000	Easy access rearward facing child seat i-Size with Isofix (0-18 kg)	537,19	650	629	0	0	0
A00999	Infant seat group 0+ (0-13 kg), rearward facing	268,60	325	314	0	0	0
SECURITY & PROTECTION							
A01251	Mini remote control 'Sport Key'	144,63	175	169	0	0	0
A00604	Dog harness	82,64	100	97	0	0	0
A00217	Anti-theft wheel locks	41,32	50	48	0	0	0
A00164	Front mud flaps	61,98	75	73	0	0	0
A00165	Rear mud flaps	61,98	75	73	0	0	0
A00228	AutoSock (snow socks)	82,64	100	97	0	0	0
A00227	Centrax snow chains (for 19" and 20" wheels)	289,26	350	338	0	0	0
WHEELS							
A01171	Winter wheels with 19" 5-spoke Black/Diamond Cut rims and 235/50 R19 - 255/45 R19 winter tyres	2.148,76	2.600	2.514	0	0	0
A01172	Winter wheels with 20" 5-double-spoke Black/Diamond Cut rims and 235/45 R20 - 255/40 R20 winter tyres	2.479,34	3.000	2.901	0	0	0

*Charging station with fixed cable of 5m or socket. A standard installation includes an installation check by phone, wall or pole mounted (max 1 meter ground works), circuit breaker, fuses, 10m cable, 10m data cable, 10m tube, if necessary a supplementary small electricity cabinet, explanation, electric scheme, legal control. No crushing & excavation works: are always part of a tailor-made proposition based on onsite visit.

O = Option



TECHNICAL SPECIFICATIONS

ENGINE	Recharge	Recharge Twin
Engine code	E400V2 (EF)	E400V6 (ED)
Engine type	One electric motor	Two electric motors
Electric engine battery	Lithium-ion	Lithium-ion
Battery energy capacity (nominal) kWh	69	78
Battery energy capacity (usable) kWh	67	75
Max. capacity kW/hp	170/231	300 (2x150)/408 (2x204)
Max. torque Nm	330	660 (2x330)
Emissions standard	EURO 6d	EURO 6d
TRANSMISSION		
Motricity	FWD	AWD
Gearbox	Single-speed	Single-speed
PERFORMANCES		
Acceleration 0-100 km/h (sec)	7,4	4,9
Top speed (km/h)	160	180
Charge time, 1-phase, AC, from 0 to 100% (32A/16A/10A) 230V (hours)	11/21/36	12/24/40
Charge time, 3-phase, AC, from 0 to 100% (16A/10A) (hours)	7/13	8/14
Charge time (fast charging), DC, from 10 to 80% (150 kW/50kW) (min.)	32/56	33/63
CONSUMPTION AND RANGE ACCORDING TO WLTP		
Electric power consumption (combined) kWh/100km	18,7-19,7	23,8-25
Electric range (combined) km	423-400	418-400
WEIGHTS AND MEASURES		
Min. curb weight (kg)	1.955	2.113
Running order weight (kg)	2.030	2.188
Max. total weight (kg)	2.480	2.650
Max. weight braked/unbraked trailer (kg)	1.500/750	1.800/750
Max. roof load capacity (kg)	75	75
Largest load volume with bench seat back folded down ISO V214-1 (incl. V209) (liters)	1.295	1.295
Largest volume load compartment ISO V214-2 (incl. V209) (liters)	545	545
Volume load compartment under luggage cover ISO V211-2 (incl. V209) (liters)	419	419
Volume under load compartment floor ISO V209 (liters)	68	68

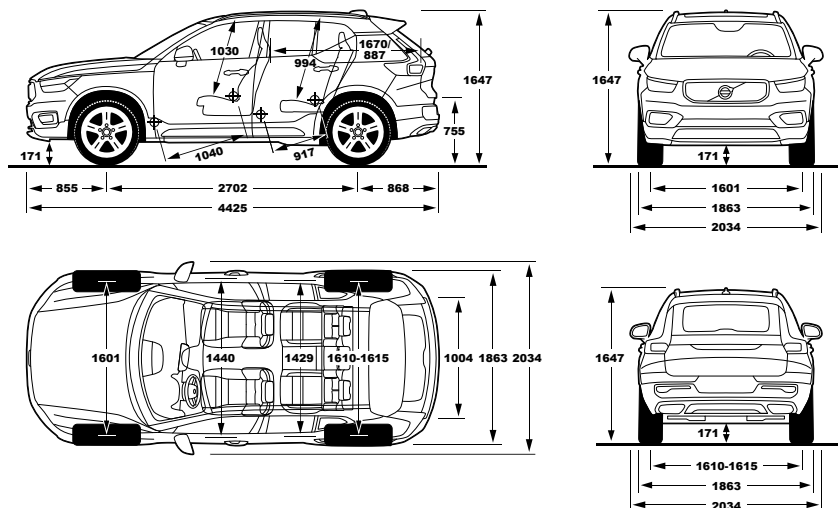

DIMENSIONS

EXTERIOR

Length x width x height (empty)	442,5 x 187,3 x 165,1 cm
Wheelbase	270,2 cm
Front track	160,1 cm
Rear track (with 19" rims/with 20" rims)	161,5/161,0 cm
Turning circle between curbs	11,4 m
Ground clearance (driver included)/foring depth	17,1/45,0 cm

INTERIOR

Headroom with sunroof front/rear	95,5 cm/97,4 cm
Headroom without sunroof front/rear	99,1 cm/99,4 cm
Shoulder room front/rear	144,0/142,9 cm
Leg room front/rear	104,0/91,7 cm
Length luggage compartment rear seats-tailgate	88,7 cm
Length luggage compartment front seats-tailgate	167,0 cm
Height luggage compartment	74,6 cm
Lifting height	75,5 cm
Width luggage compartment between wheel arches	100,4 cm
Min./max. width tailgate opening	94,7/105,9 cm

WARRANTY:

3 year or 100.000 km factory warranty (whichever comes first) included.

The batteries undergo normal wear depending on age and use. If the battery capacity falls below 70% of the original state within 8 years or 160,000 km (whichever is reached first), the battery will be replaced under guarantee.

VOLVO CARE OFFER FOR VOLVO RECHARGE PURE ELECTRIC

The Volvo Care Offer 'Service & Maintenance for Volvo Recharge Pure Electric' is included* with the purchase of any new, all-electric Volvo. This page describes the services and parts included in the maintenance and service programme for these vehicles.

The Volvo Care Offer 'Service & Maintenance for Volvo Recharge Pure Electric' is valid for a period of **3 years from the date of delivery or 100.000 km** (whichever comes first). The vehicle owner can have the periodic maintenance of his/her Volvo Recharge Pure Electric carried out at the prescribed service intervals in any authorised Volvo workshop in Belgium or the Grand Duchy of Luxembourg.

Our in-house trained Volvo technicians maintain the vehicle and keep it in top condition. They also carry out a health check and verify whether the vehicle is equipped with the latest software.

The detailed terms and conditions applicable to this Volvo Care Offer 'Service & Maintenance for Volvo Recharge Pure Electric', including restrictions, will be handed over to the first owner of the vehicle by the Volvo retailer who delivers the vehicle. These will remain valid for the stated duration and mileage, even if there has been a change in ownership.

The Volvo Care Offer 'Service & Maintenance for Volvo Recharge Pure Electric' applies to the vehicle specified on page 3 in this price list, and for a period of **3 years from the date of delivery or 100.000 km** (whichever comes first). The Volvo Care Offer 'Service & Maintenance for Volvo Recharge Pure Electric' covers periodic maintenance services, every **24 months or every 30.000 km** (whichever comes first), and includes replacement of the wear and tear parts listed below.

- Volvo Car Genuine Service at scheduled service intervals
- health check
- air filter replacement
- tyre sealant replacement in accordance with the prescribed interval
- cleaning of the sensors and cameras for the safety systems under the windscreen
- software updates
- **Includes** replacement of the following wear and tear parts: brake pads and discs (when required) and windscreen wiper blades (1x per year).
- **Excludes** replacement of wear and tear parts not explicitly mentioned above.

* Volvo vehicles with specific service programmes (such as taxis, police vehicles or vehicles with other specific purposes) are not eligible for the Volvo Care Offer 'Service & Maintenance for Volvo Recharge Pure Electric' described above.

The 'Volvo Car Genuine Service' maintenance programme may be amended by Volvo Cars, provided that such amendment will not affect the application of the Volvo Cars warranty or affect the vehicle owner's rights under the Volvo Care Offer.

The inclusion of wear and tear parts in the Volvo Care Offer 'Service & Maintenance for Volvo Recharge Pure Electric' does not affect the reference to 'wear and tear' in the Service and Warranty Booklet.

The Volvo Care Offer 'Service & Maintenance for Volvo Recharge Pure Electric' is subject to the terms and conditions regarding service and maintenance. Should you have any questions about this, please do not hesitate to contact our Volvo retailers.

VOLVO CARE OFFER GENERAL TERMS AND CONDITIONS 'SERVICE & MAINTENANCE FOR VOLVO RECHARGE PURE ELECTRIC'

1. Application of the conditions

These Volvo Care Offer terms and conditions 'Service & Maintenance for Volvo Recharge Pure Electric' apply to new, all-electric Volvo vehicles. These terms and conditions form part of the purchase contract for the vehicle. Regardless of whether the vehicle is purchased from a Volvo Car Corporation entity or from a Volvo retailer, the Volvo National Sales Company or Volvo's importer in the country of first purchase is responsible for this service programme.

2. Validity of the Volvo Care Offer 'Service & Maintenance for Volvo Recharge Pure Electric'

- The Volvo Care Offer 'Service & Maintenance for Volvo Recharge Pure Electric' is valid for a defined limited period of time, as previously stated and includes, where applicable, defined wear and tear parts of the vehicle, as previously specified. Any work carried out that is not covered by the Volvo Care Offer 'Service & Maintenance for Volvo Recharge Pure Electric' will remain the responsibility of the customer. When all required work has been carried out or when the limited validity period has expired, the Volvo Care Offer 'Service & Maintenance for Volvo Recharge Pure Electric' will end. The maintenance programme will also be considered terminated if maintenance should have been carried out in accordance with the prescribed maintenance intervals (as stated in the owner's manual and the Service and Warranty Booklet for the vehicle) but the vehicle has not been presented to an authorised Volvo workshop to carry out the Volvo Car Genuine Service.
- The Volvo Care Offer 'Service & Maintenance for Volvo Recharge Pure Electric' is linked to the market in which it was originally sold. The periodic maintenance of the vehicle according to the prescribed service intervals can only be carried out in the authorised Volvo workshops within that market.
- Volvo Cars has the right to terminate the Volvo Care Offer 'Service & Maintenance for Volvo Recharge Pure Electric' with immediate effect should the conditions of Volvo Cars' operations in the relevant market change significantly due to circumstances outside of Volvo Cars' control and should these circumstances make it very difficult for Volvo Cars to carry out the Volvo Care Offer 'Service & Maintenance for Volvo Recharge Pure Electric'. Both parties have the right to terminate the Volvo Care Offer 'Service & Maintenance for Volvo Recharge Pure Electric' with immediate effect should the other party be in serious or repeated breach of its obligations under these terms and conditions.

3. Owner obligations

Periodic maintenance of the vehicle must be carried out according to Volvo Cars' recommendations. Volvo Car Genuine Service in accordance with the prescribed

service intervals, depends on time and annual mileage and may occur at different time intervals. The validity of the Volvo Care Offer 'Service & Maintenance for Volvo Recharge Pure Electric' further requires that the vehicle owner:

- Drives, maintains and manages the vehicle in accordance with the instructions in the vehicle owner's manual (extended version can be found at volvocars.com) and in the Service and Warranty Booklet (included in the vehicle documents).
- Conducts routine checks of the fluid levels in the vehicle between recommended service intervals and, if necessary, fills up at its own expense.
- Delivers the vehicle, at its own expense, to an authorised Volvo workshop for maintenance in accordance with the service intervals specified in the owner's manual and the vehicle Service and Warranty Booklet.

4. Transfer of the Volvo Care Offer 'Service & Maintenance for Volvo Recharge Pure Electric'

If the vehicle is sold or otherwise transferred to a new owner, the Volvo Care Offer 'Service & Maintenance for Volvo Recharge Pure Electric' follows the vehicle. All remaining services in the maintenance programme can then be used by the new owner in accordance with these terms and conditions.

5. Disclaimer

This maintenance programme Volvo Care Offer 'Service & Maintenance for Volvo Recharge Pure Electric' does not include any obligation on the part of any Volvo retailer or Volvo Cars to reimburse the vehicle owner in any way for costs, loss of income, loss of time or any other damage caused by the vehicle being temporarily handed over to the workshop for maintenance, or by the vehicle not being able to be used during the period in which it has been handed over to the workshop for scheduled maintenance. Nothing in these terms and conditions shall exclude, limit or modify any warranty, guarantee, term or condition, right or remedy implied or imposed by applicable law which cannot be legally excluded or limited.

6. Applicable Laws and Disputes

In the event of any dispute concerning the interpretation or application of the Volvo Care Offer 'Service & Maintenance for Volvo Recharge Pure Electric', the parties shall seek to resolve this by mutual agreement. The Volvo Care Offer 'Service & Maintenance for Volvo Recharge Pure Electric' shall be governed by the laws of the country of first purchase of the vehicle and in the event of any dispute the competent national courts shall have jurisdiction.

V O L V O

Some of the information in this brochure may be incorrect due to changes to the product specifications introduced after the brochure was published, such as consumption figures. Volvo Car Belux reserves the right to make changes to the prices, colours, materials, specifications and models at any time without prior notice. The images shown are for information purposes only and may differ from the actual product. Certain equipment, options or accessories described or shown are available at an additional cost. All list prices in this brochure are recommended resale prices. VAT applicable is 21% for Belgium and 17% for the Grand Duchy of Luxembourg. Ask your Volvo distributor for the latest information before ordering.

The prices for accessories always include fitting (unless otherwise specified) and (where applicable) Recupel (for Belgium) or Ecotrel (for the Grand Duchy of Luxembourg). Recommended prices for winter wheel kits (composed of 4 complete winter wheels with rims and tyres) always include environmental contribution (Recytyre for Belgium), but without fitting and software update (if needed).

Environmental information [Royal Decree 19/03/2004]: all self-respecting Volvo drivers put safety first.
R.P.: Philip Verschooren - Registered address/head office: Volvo Car Gent SA/NV, Avenue John Kennedy 25, B-9000 Ghent - Place of business: Volvo Car Belux - VAT no.: BE 0420.383.548

VOLVOCARS.BE/.LU
2021 - V03.MY22

